









Switching valve pneumatically operated - SV and S3 Series

Valvola di commutazione ad azionamento pneumatico - SERIE SV e S3

- AISI 316L construction
- Excellent accuracy
- Easy, accurate adjustment
- Different type of range
- 2/2 valve on off control
- 3/2 normally open switching valve
- ATEX 2014/34/UE - II2GD c IICT6 X 
-  &  approved / SIL 3 - IEC 61508 

- Materiale di costruzione AISI 316
- Eccellente precisione
- Facile e precisa regolazione
- Differenti campi di regolazione
- Valvola 2/2 di controllo on off
- Valvola di commutazione 3/2 NA
- ATEX 2014/34/UE - II2GD c IICT6 X 
- Approvato  ed  / SIL 3 - IEC 61508 



The Types SV switching valves is a pneumatically operated and controlled units, built with a wide range of capabilities to handle those switching application that involve on-off control, and failure modes. Operation of valve occurs when the pneumatic signal changes accordingly to the spring range. The Sv model switching valve is typically used as a normally close on-off switch. The model S3 switching valve directs flow through three ports. With a choice of springs for optimum resolution, the switching point is set to a specific requirement by an adjusting screw placed on top of the cover.

La valvola di commutazione tipo SV è un dispositivo azionato e controllato pneumaticamente, costruito con un'ampia gamma di possibilità per controllare applicazioni di commutazione che coinvolgono il controllo on-off e le modalità guasto. Il funzionamento della valvola avviene quando il segnale pneumatico varia in funzione delle caratteristiche della molla utilizzata. La valvola di commutazione modello SV è utilizzata tipicamente come interruttore on-off normalmente chiuso. Il modello S3 consente il passaggio del flusso in tre connessioni. Con la possibilità di scegliere diverse molle per una risoluzione ottimale, il punto di commutazione è regolato per mezzo di una vite posta nella parte superiore del coperchio.

Technical Data

Caratteristiche Tecniche

Port thread / Connessioni	1/4 NPT
Signal port / Connessioni segnale	1/8" / 1/4" NPT
Body material / Materiali corpo Plastic materials / Materiali plastici	AISI 316 NBR
Maximum inlet pressure (psi) Pressione massima ingresso (bar)	120 8
Maximum signal (psi) Segnale Massimo (bar)	100 7
Control range (psi) Campo di regolazione (bar)	3-30 3-60 5-120 0.2-2 0.2-4 0.4-8
Temperature range / Temperatura	-20°C +80°C

Option

Opzioni

Different control range
Differenti campi di controllo

Panel mount
Montaggio pannello

Wall bracket
Staffa

Pressure gauge
Manometro

Temperature range
Campi di Temperatura

Valve and wall bracket dimension

Dimensioni valvola e staffa di fissaggio

Model SV

Modello SV

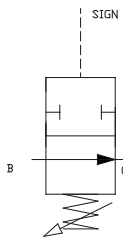

Model S3

Modello S3

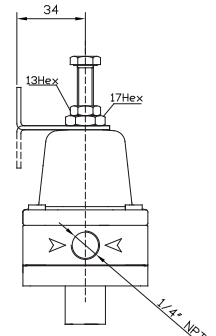
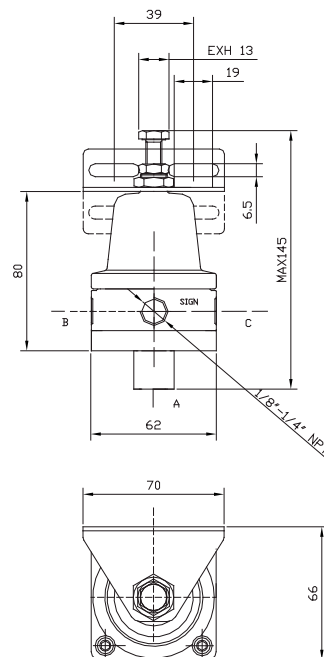
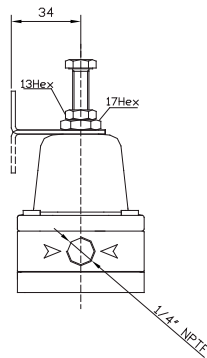
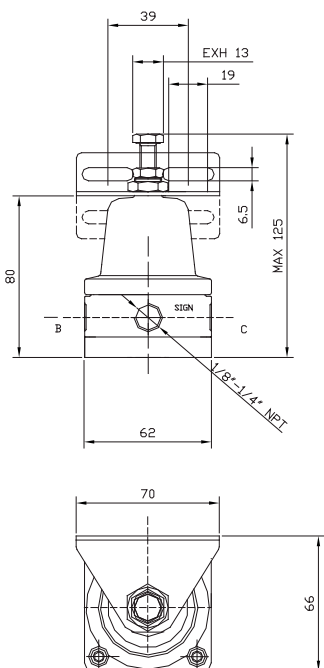
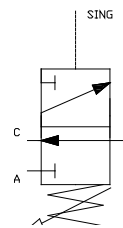

Ordering information

Come ordinare

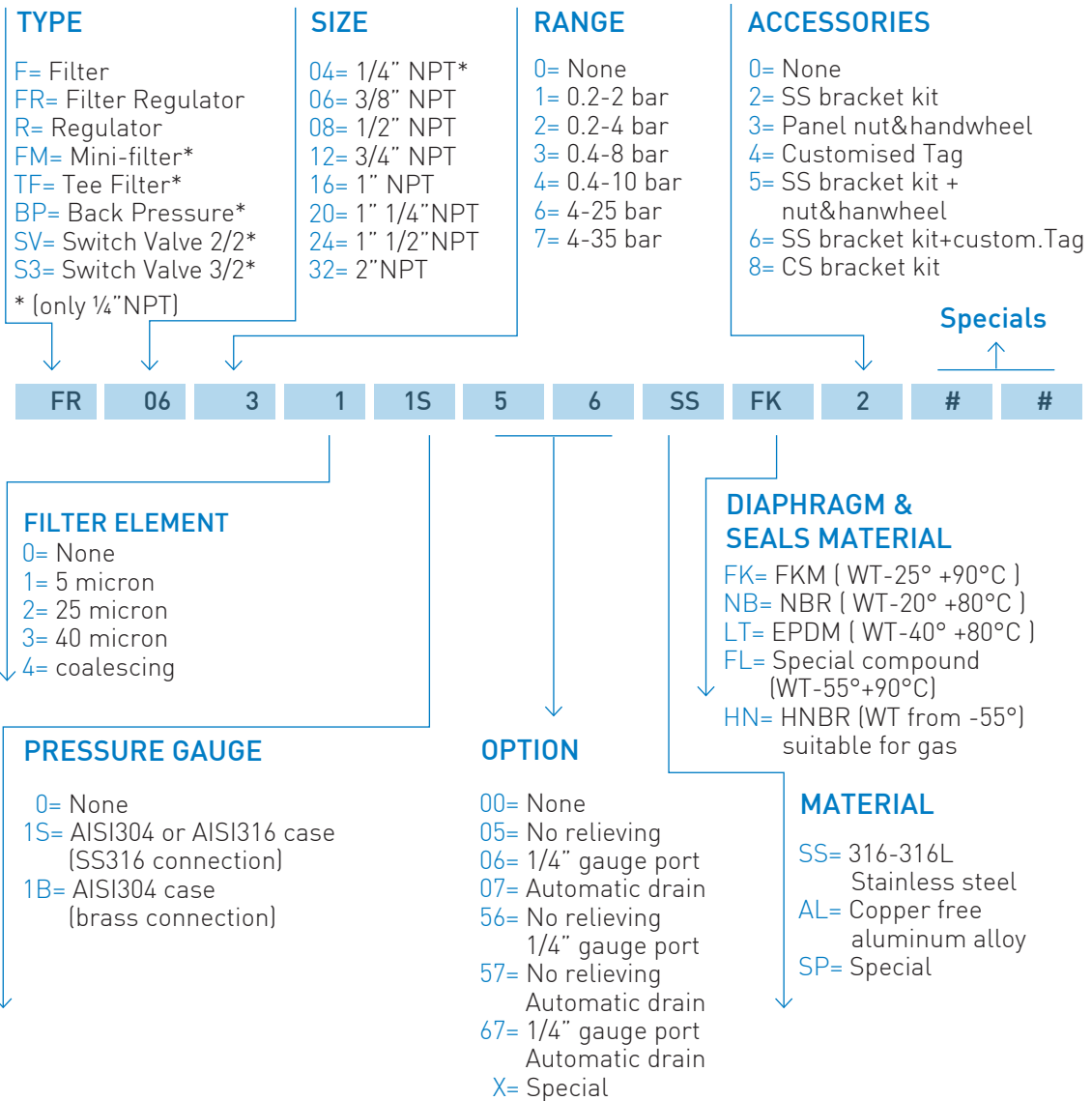

CODE EXAMPLES

FR 06 3 3 1S 0 7 SS FK 2

3/8"NPT, SS316, 0 to 8 bar range, filter regulator, with 40 micron filtering element, relieving, SS pressure gauge, automatic drain, ss bracket kit and FKM diaphragm & seals
 Filtro regolatore da 3/8"NPT in AISI316, range regolato 0/8 bar, elemento filtrante da 40 micron, manometro tutto inox, relieving, scarico condensa automatico, staffa inox, diaframma e tenute in FKM

FR 06 3 1 00 0 0 SS FK 0

3/8"NPT, SS316, 0 to 8 bar range, filter regulator, with 5 micron filtering element, relieving and FKM diaphragm & seals
 Filtro regolatore da 3/8"NPT in AISI316, range regolato 0/8 bar, elemento filtrante da 5 micron, relieving, diaframma e tenute in FKM

