

D20 Compact Digital Positioner

Product
Information





D20 Compact Digital Positioner

Description

D20 is a compact digital positioner that is very simple and quick to install and operate.

To calibrate it, simply press the button for 5 seconds, D20 will auto-calibrate and tune itself in a few seconds. D20 can be fitted with optional 4-20 mA feedback transmitter and limit switches. Optional LCD with menu is available on D22. HART communication is optional.

For visual indication you can select between flat arrow indicator or a dome indicator.

Features and Benefit

- Simple to operate
- Calibrates itself in a few seconds
- Modular design, plug in and add on modules
- Intrinsically safe, Non-Incendive or Explosion proof, ATEX & FM
- Suits Rotary and Linear applications
- Add in switch and 4-20mA position feedback option
- VDI/VDE 3845
- VDI/VDE 3847
- HART option
- LCD – Menu option

Intrinsically safe:

ATEX II 1 G Ex Ex ia IIC T4

FM IS Class 1, Div1, Group A-D, T4 Class 1, Zone 0, AE Xia IIC, T4

FM Non incendive Class 1, Div 2, Group A-D, T4 NIFW, Class 1, Div 2, IIC

Explosion proof:

ATEX II 2 GD Ex EEx d IIB + H2 T6 (Ta: 65°C) T5(Ta: 80°C)

FM XP/II/1/BCD/T6 Ta = 65°C / T5 Ta = 80°C DIP/II/1/EFG Ta = 65°C / T5 Ta = 80°C, Type 4X

IEC Ex d IIB + H2 T6 Gb Ta: 60°C, Ex tb IIC 100°C Db Ta: 80°C



D22, LCD+Menu

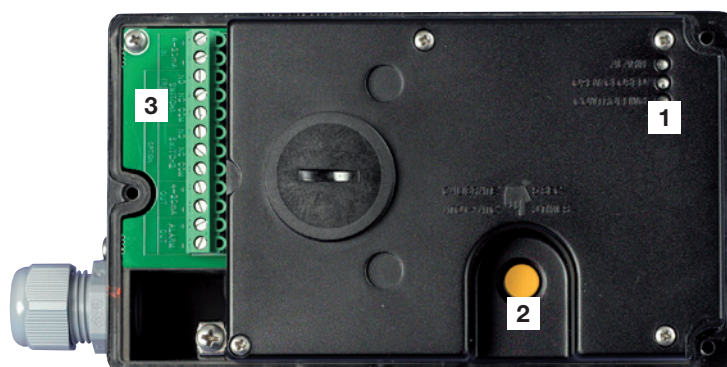

D20

1. LED's indication
2. Calibration/configuration button
3. Add in feedback option

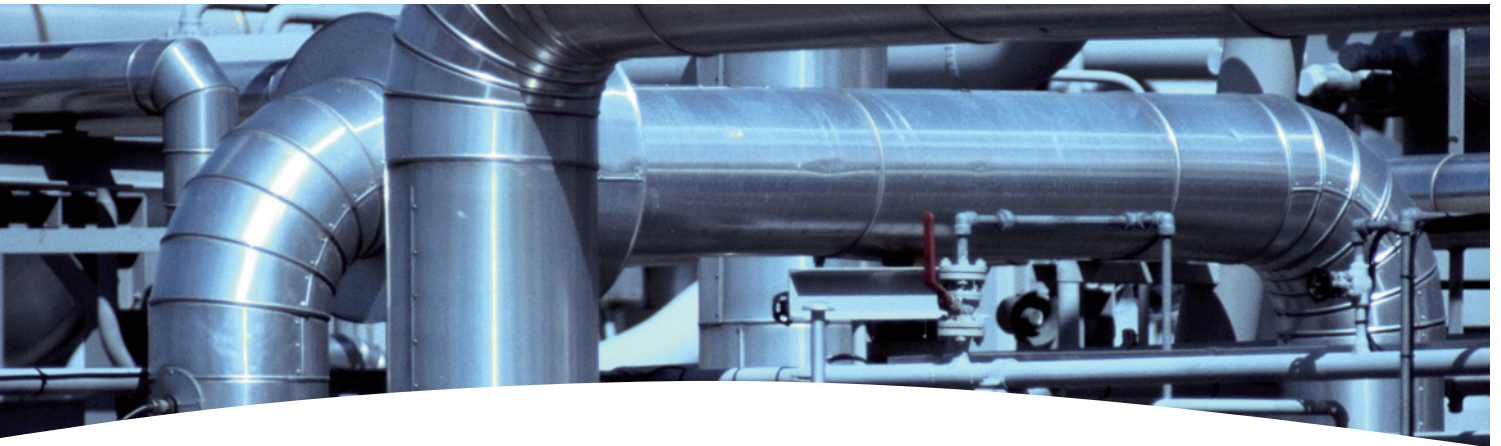

Press button and D20 will auto calibrate itself.



Press button and D20 will auto calibrate itself.



D20 modular design gives you many options.



D20 Explosion proof on linear control valve.



D20 suits both rotary and linear actuators.

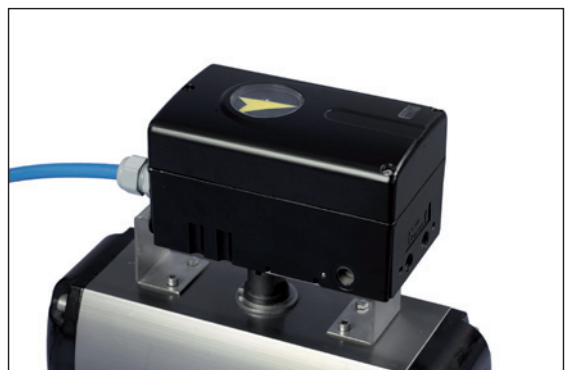

D20 mounted according to VDI/VDE 3845.

D20 and D22 Technical data

D20/D22 Compact Digital Positioner

Input signal	4-20 mA
Current supply min.	3,6 mA
Current supply Max.	150 mA
Load Standard	400 ohm at 20mA
Load HART	470 ohm at 20mA
User Interface D20	Single push button, LEDs
User Interface D22	LCD menu + 5 push buttons, LEDs
Voltage drop Standard	8 VDC at 20mA
Voltage drop HART	9.4 VDC at 20mA
Angle of rotation min	0-40°
Angle of rotation Max	0-90°
Air supply range	1.5 – 6 bar / 22 – 87 psi
Out put	0-100% of air supply pressure
Air supply quality	Free from oil, dust and moisture IEC 770, ISA 7.0.01
Air supply effect	<0.1%FS for 10% pressure change at 6Bar / 87 psi
Ingress protection	IP66 / Nema 4X
Operating humidity	0-100% rh non-condensing
Air connections	¼" NPT
Gauge ports	1/8" NPT (Bolt on block)
Cable entry	2 x ½" or 2 x M20x 1,5
Terminals	Screw terminals 2,5 mm ² (AWG 14)
Operating Temperature	-20 to +85°C / -4 to +179°F -40°C/F (optional)
Storage temperature	-40 to +85°C / -40 to +179°F
Air delivery capacity	7 Nm ³ /h @ 6 bar / 4.12 SCFM @ 87 psi
Air delivery capacity Double acting	7 Nm ³ /h @ 6 bar / 4.12 SCFM @ 87 psi
Air consumption Single acting	0.120 Nm ³ /h @ 6 bar / 0.071 SCFM @ 87 psi
Air consumption Double acting	0.120 Nm ³ /h @ 6 bar / 0.071 SCFM @ 87 psi
Cv air delivery Single acting	0,12
Cv air delivery Double acting	0,12
Cut off function	Close 0.5% Open 99.5%
Linearity	<1%
Sensitivity	<0.05%
Resolution	<0,1%
Repeatability	<0.2%
Hysteresis + dead band	<0.5%
Temp effect	<0.1%/10K
Mounting position effect	<0,2%
CE	93/68/EEC, 2004/108/EEC, 2006/95/EEC
Housing material	Die cast Aluminium
Surface treatment	Powder coating
Soft goods	Nitrile
Weight	1.4 kg / 3.1 lbs

D20EX, D22EX (as above except)

Air delivery capacity	6,3 Nm ³ /h @ 6 bar / 3,7 SCFM @ 87 psi
Cv air delivery:	0.08
Gauge ports	2 x 1/8" NPT
Weight, AI version	3 kg / 6.6 lbs
Weight, Stainless steel version	5.9 kg / 13 lbs

Optional plug in module

Mechanical switches	
Type	SPDT
Size	Sub Sub miniature
Rating	3A, 125 VAC / 2A, 30VDC
Mechanical life	>1 x 10 ⁶ operations
Namur sensors	
Type	P+F NJ2 V3 N Inductive DIN 19234
Load current	<1mA>3mA
Voltage range	5-25 VDC
Hysteresis	3-15% (5% typical)
Temp range	-25° to +100° C (-248° to +373° F)
Namur sensors	
Type	P+F SJ2-N
Normal Voltage	8 VDC
Load current	1mA<I<3mA
Voltage range	5-25 VDC
Hysteresis (max)	0.2%
Temp range	-25° to +100° C (-248° to +373° F)
Namur sensors	
Type	P+F SJ2-SN
Normal Voltage	8 VDC
Load current	1mA<I<3mA
Voltage range	5-25 VDC
Hysteresis (max)	(0.2%)
Temp range	-40° to +100° C (-233° to +373° F)
Namur sensors	
Type	P+F SJ2-S1N
Normal Voltage	8 VDC
Load current	1mA<I<3mA
Voltage range	5-25 VDC
Hysteresis (max)	0.2%
Temp range	-25° to +100° C (-248° to +373° F)
Proximity switches	
Type	SPDT
Rating	10W
Voltage max	200VDC
Current max	500mA
Contact resistance max	0.2 Ohm
Operating time	1.0 ms
Transmitter	
Power supply	12-28 VDC
Output	1-22 mA
Resolution	0.1%
Linearity	±0.5%
Load impedance	600 Ohm at (12 VDC and 20mA)
Alarm Output	
Supply	3-28 VDC
Output	20mA @ 24 VDC



Spindles and Dimensions drawings (mm)

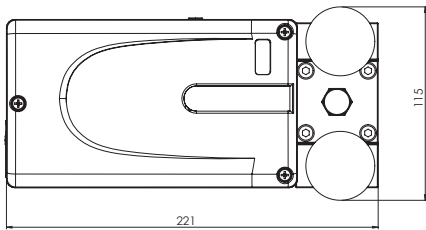

Double acting block

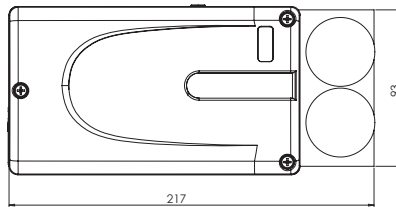

Gauge block

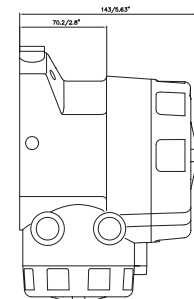
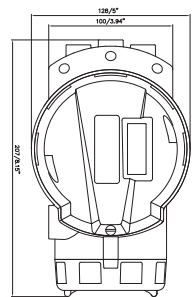
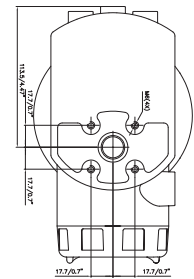

Explosion proof

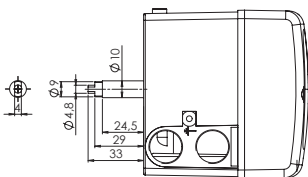

S23 "Namur Spindle"

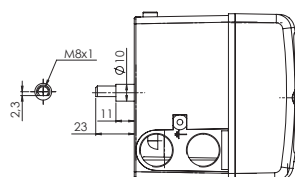

S39 "D Spindle"

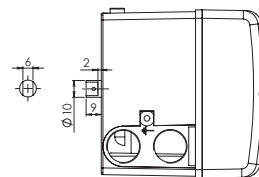

S09 "Double D Spindle"

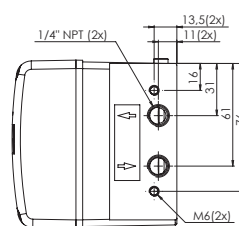
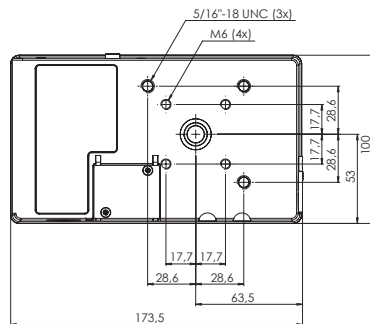
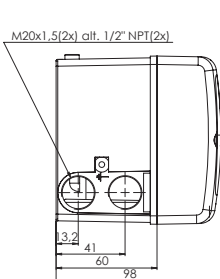



D20 Compact Digital Positioner Model Code

- A = Model no**
 D20 Digital compact positioner, Single button, LED status
 D22 Digital compact positioner, LCD – Menu, LED status
- B = Approval, Certificate**
 D General purpose version
 I Intrinsically safe version ATEX, FM, FM NI
 E Explosion proof ATEX, FM, IEC
- C = Connections Air, Electrical**
 M 1/4" NPT air, M20 x 1,5 electrical x 2
 N 1/4" NPT air, 1/2" NPT electrical x 2
- D = Housing/Surface treatment**
 U Aluminium/Powder epoxy, black
 R Aluminium/Powder epoxy, Remote mounted position sensor
 S Stainless steel (Explosion proof only)
- E = Function**
 S Single acting function
 D Double acting function, incl gauges (x2) Stainless/Brass
 (Not possible for Explosion proof B = E)
- F = Mounting options / Spindle**
 09 Double D type (Adaptors available 01/06/26/30/36)
 12 Flowtop, D-style+ nut, Direct mounting to Flowact
 23 VDI/VDE 3845 rotary
 39 Flat D type, for linear, IEC 534-6
- G = Cover and Indicator**
 PVA PMV, Black cover, Arrow indicator (Not for B = E)
 PVB PMV, Black cover, No indicator
 PVD PMV, Black cover, Dome indicator (Not for B = E)
- H = Temperature/seals**
 Z Standard -20°C to 85°C (-4°F to 185°F)
 Q Low temp -40°C to 85°C (-38°F to 185°F)
- I = Input signal/Protocol**
 4 4-20 mA / none
 5 4-20 mA, / HART
- J = Feedback option, 4-20 mA transmitter, switches**
 X No feedback option
 T 4-20 mA transmitter only
 (Below not possible for Explosion proof version, B= E)
 S Limit switches Mechanical SPDT + 4-20mA
 N Namur V3 type sensor, P+F NJ2-V3-N + 4-20mA
 P Limit switches Proximity SPDT + 4-20mA
 4 Slot type Namur sensor, P+F SJ2-S1N + 4-20mA
 5 Slot type Namur sensor, P+F SJ2-SN + 4-20mA
 6 Slot type Namur sensor, P+F SJ2-N + 4-20mA
- K = Options, Add in electronics**
 0 Standard diagnostics
 1 Advanced, build in pressure sensor
- L = Accessories**
 X No accessories
 M Gauge option (2 x gauges included)
 N Gauge option (2 x gauges included)

Example: D20DMU-S23PVA-Z5S0M



p/n: FCD PMENBR0015-02



Hazardous Locations

Intrinsically safe
08ATEX 1362X II 1 G Ex ia IIC T4 Ta: 85°C



FM IS Class 1, Div1, Group A-D, T4 Class 1, Zone 0, AE Xia IIC, T4
FM Non incandive Class 1, Div 2, Group A-D, T4 NIFW, Class 1, Div 2, IIC, T4 NIFW

Explosion proof

03ATEX111 II 2 GD EEx d IIB + H₂ T6 T6 (Ta:65°C) T5(Ta:80°C)



FM XP/II/1/BCD/T6 Ta = 65°C / T5 Ta = 80°C
DIP/II/1/EFG Ta = 65°C / T5 Ta = 80°C, Type 4X

IEC Ex d IIB + H₂ T6 Gb Ta:60°C, Ex tb IIC 100°C Db Ta: 80°C

Flowserve Corporation has established industry leadership in the design and manufacture of its products. When properly selected, this Flowserve product is designed to perform its intended function safely during its useful life. However, the purchaser or user of Flowserve products should be aware that Flowserve products might be used in numerous applications under a wide variety of industrial service conditions. Although Flowserve can (and often does) provide general guidelines, it cannot provide specific data and warnings for all possible applications. The purchaser/user must therefore assume the ultimate responsibility for the proper sizing and selection, installation, operation, and maintenance of Flowserve products. The purchaser/user should read and understand the Installation and Maintenance (I & M) instructions included with the product, and train its employees and contractors in the safe use of Flowserve products in connection with the specific application.

While the information and specifications contained in this literature are believed to be accurate, they are supplied for informative purposes only and should not be considered certified or as a guarantee of satisfactory results by reliance thereon. Nothing contained herein is to be construed as a warranty or guarantee, express or implied, regarding any matter with respect to this product. Because Flowserve is continually improving and upgrading its product design, the specifications, dimensions and information contained herein are subject to change without notice. Should any question arise concerning these provisions, the purchaser/user should contact Flowserve Corporation at any one of its worldwide operations or offices.

©2010 Flowserve Corporation, Irving, Texas, USA. Flowserve and PMV are registered trademarks of Flowserve Corporation.

Palmstierna International AB

Korta Gatan 9
SE-171 54 Solna
SWEDEN
Tel: +46 (0) 8 555 106 00
Fax: +46 (0) 8 555 106 01
E-mail: infopmv@flowserve.com

Germany

Flowserve
Sperberweg 16
D-41468 Neuss
GERMANY
Tel: +49 (0) 2131 795 74 80
Fax: +49 (0) 2131 795 74 99
E-mail: pmvgermany@flowserve.com

UK

Flowserve
Abex Road
Newbury, Berkshire, RG14 5EY
UK
Tel: +44 (0) 1635 46 999
Fax: +44 (0) 1635 36 034
E-mail: pmvukinfo@flowserve.com

Scandinavia

Palmstiernas Svenska AB
Box 21
663 21 Skoghall
Sweden
Tel: +46 (0)54 52 14 70
Fax: +46 (0)54 52 14 42
e-mail: info@palmstiernas.se

Italy

Flowserve Spa
Via Prealpi, 30
20032 Cormano (Milano)
ITALY
Tel: +39 (0) 2 663 251
Fax: +39 (0) 2 615 18 63
E-mail: infoitaly@flowserve.com

USA, Mexico

PMV-USA
14219 Westfair West Drive
Houston, TX 77041
USA
Tel: +1 281 292 7500
Fax: +1 281 292 7760
E-mail: pmvusa@flowserve.com

Canada

Cancoppas Limited
2595 Dunwin Drive, Unit 2
Mississauga, Ont L5L 3N9
CANADA
Tel: +1 905 569 6246
Fax: +1 905 569 6244
E-mail: controls@cancoppas.com

Asia Pacific Headquarters

Flowserve Pte Ltd.
No. 12 Tuas Avenue 20
REPUBLIC OF SINGAPORE 638824
Tel: +65 (0) 687 98900
Fax: +65 (0) 686 24940
E-mail: fcdasiaprocess@flowserve.com

South Africa

Flowserve
Unit 1, 12 Director Road
Spartan Ext. 2
1613 Kempton Park, Gauteng
SOUTH AFRICA
Tel: +27 (0) 11 397 3150
Fax: +27 (0) 11 397 5300

The Netherlands

Fabromatic
Rechtzaad 17
NL-4703 RC Roosendaal
Tel.: +31(0)165598898
Fax: +31(0)16555670

China

Flowserve
Hanwei Building
No. 7 Guanghua Road
Chao Yang District
100004 Beijing
CHINA
Tel: +86 (10) 6561 1900
Fax: +86 (10) 6561 1899

www.pmv.nu